

Going on a Trip

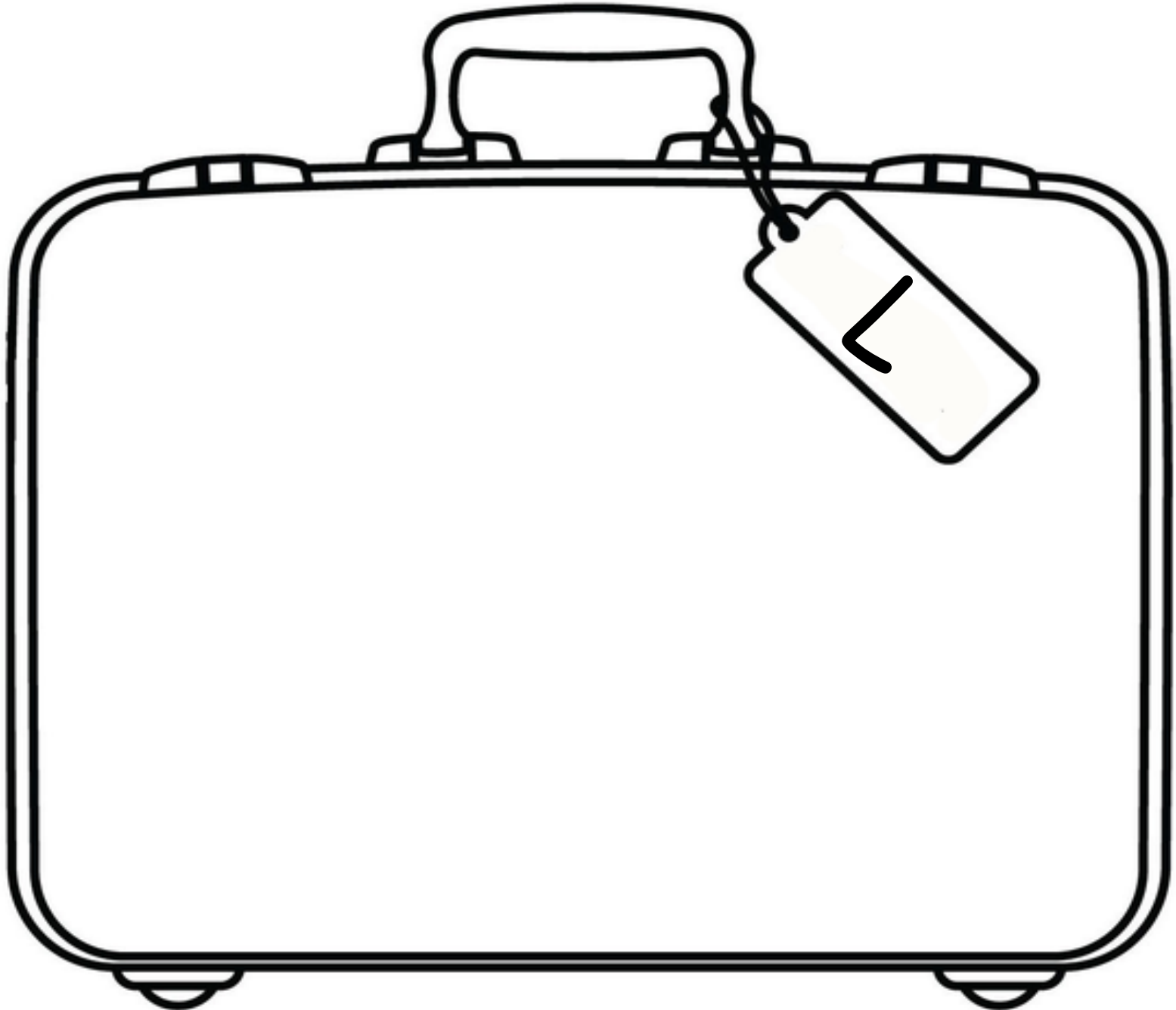

Going on a Trip

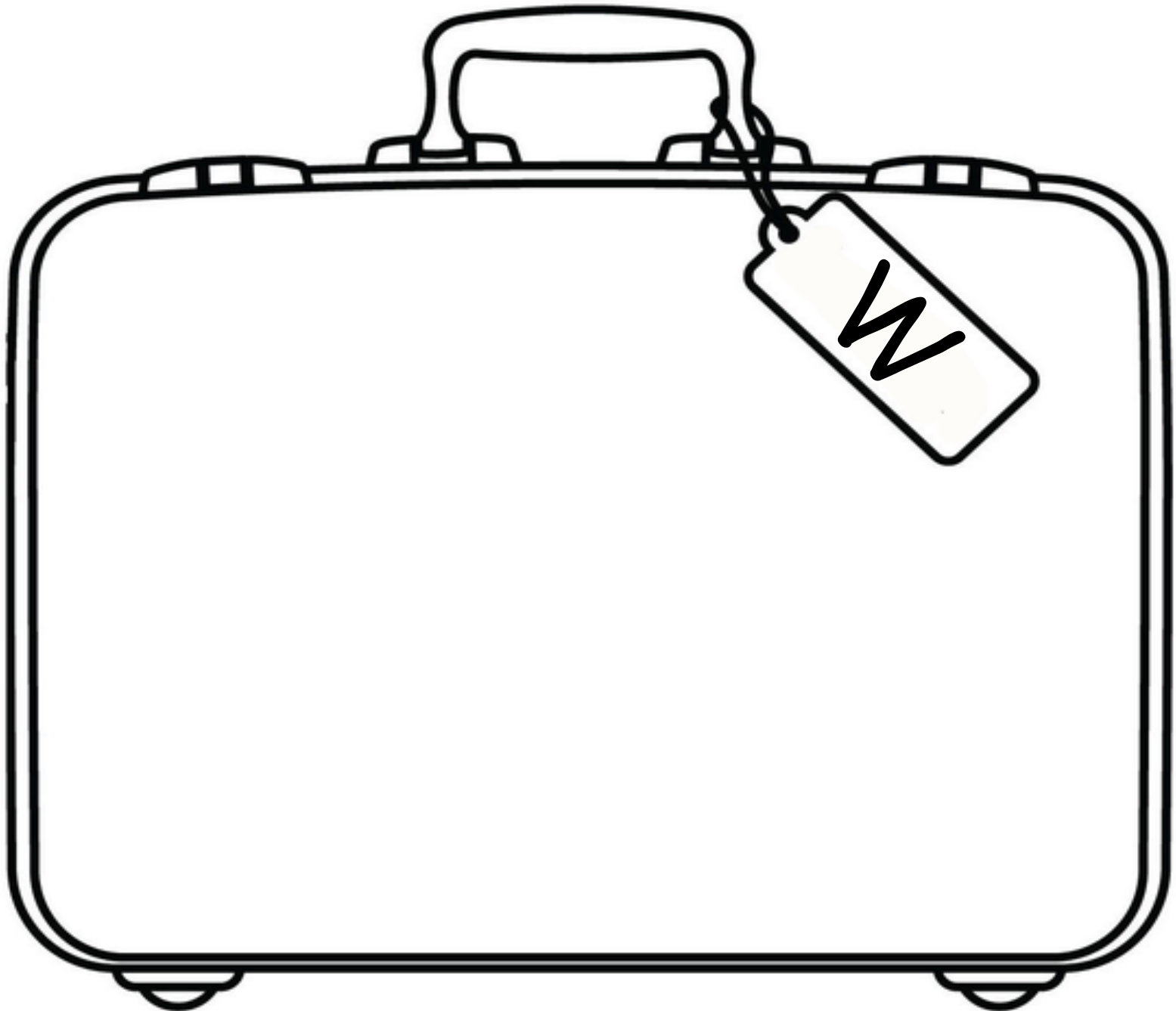

Going on a Trip

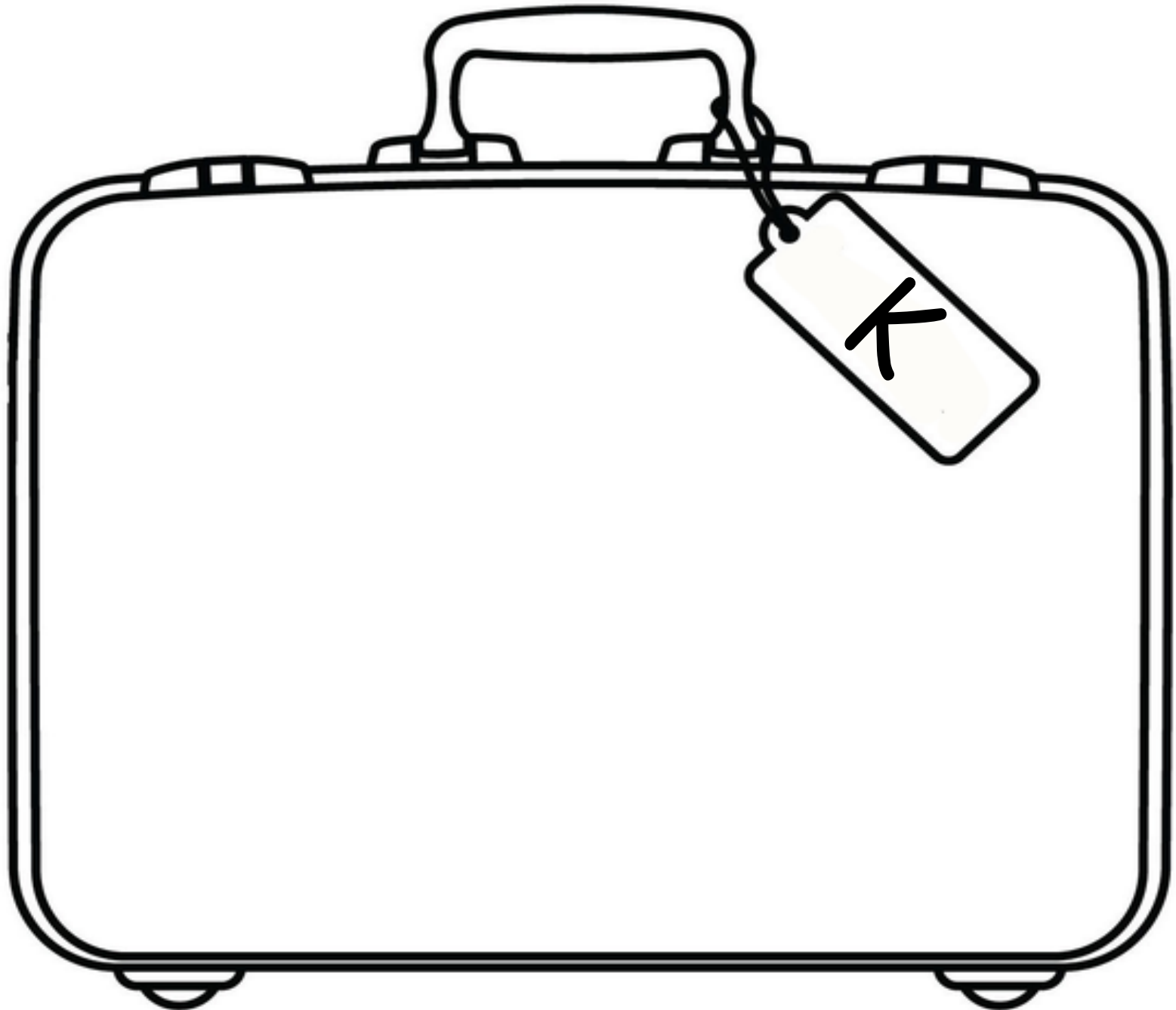

Going on a Trip

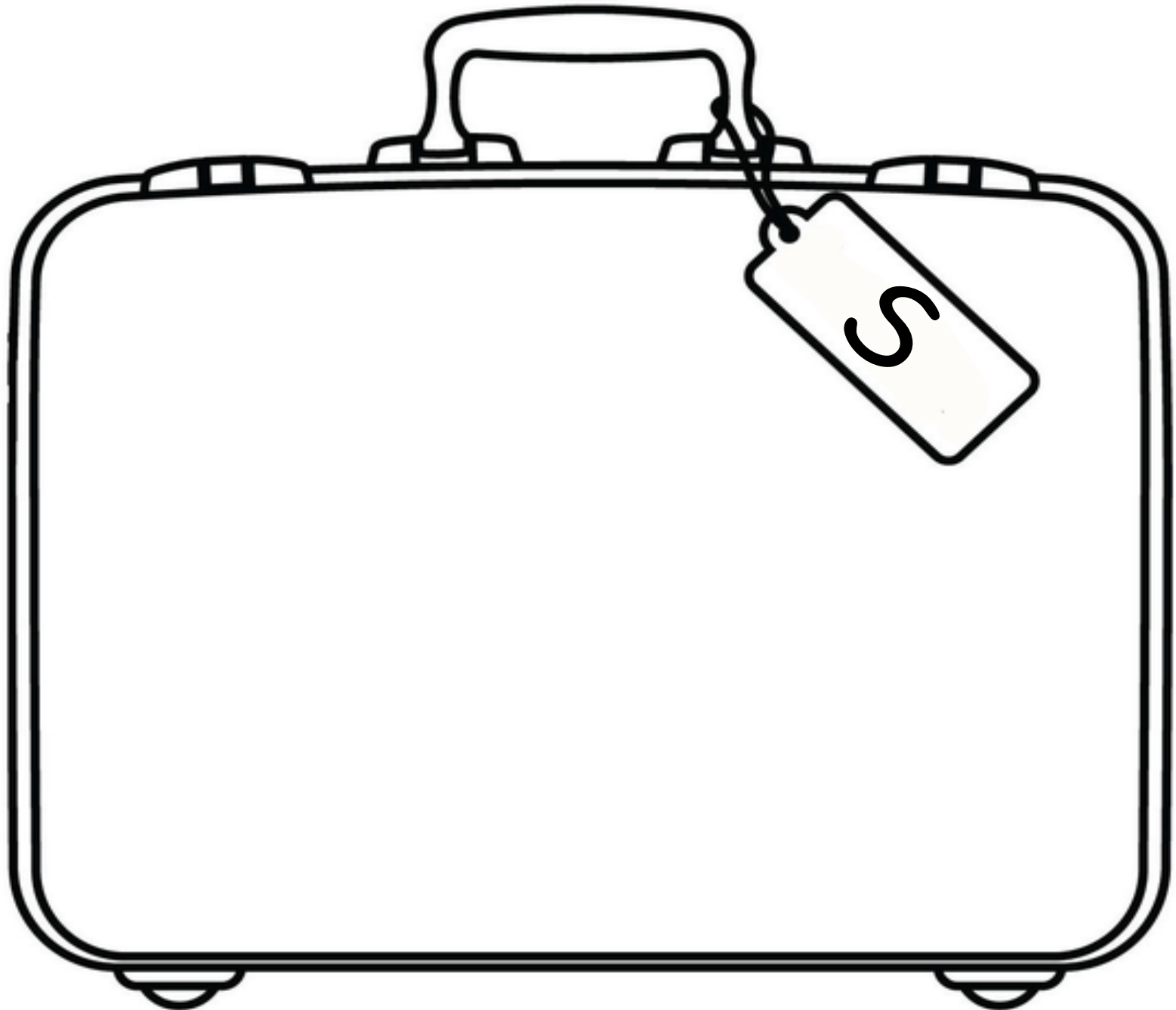

Squirrel Search

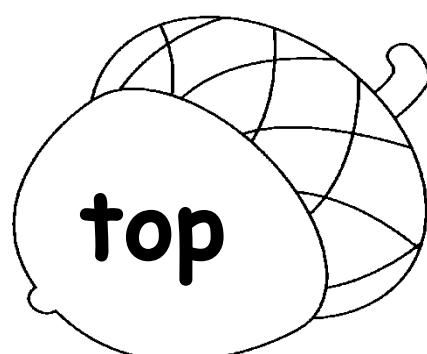
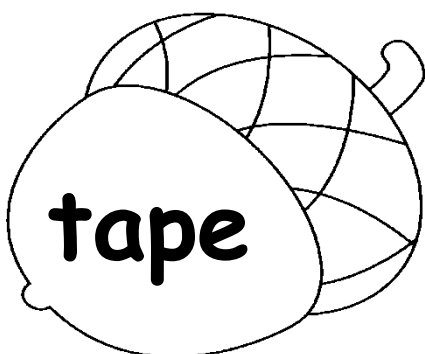
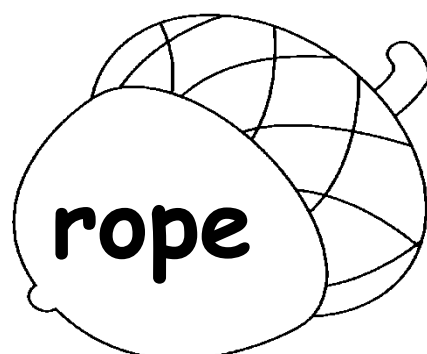
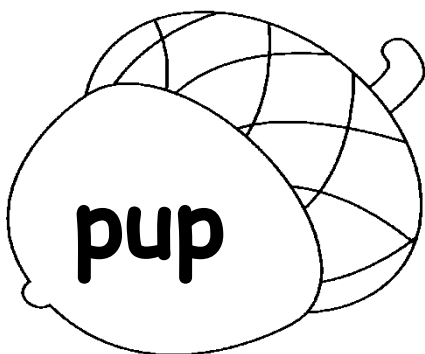
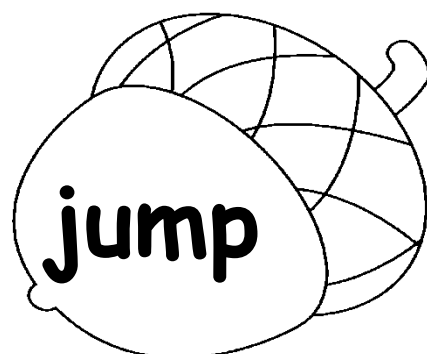
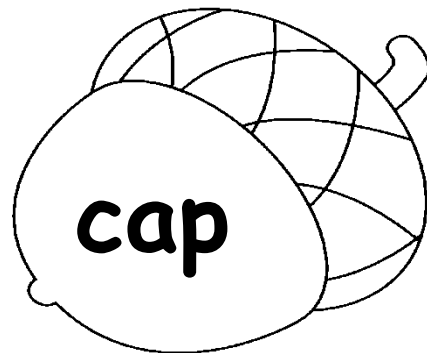
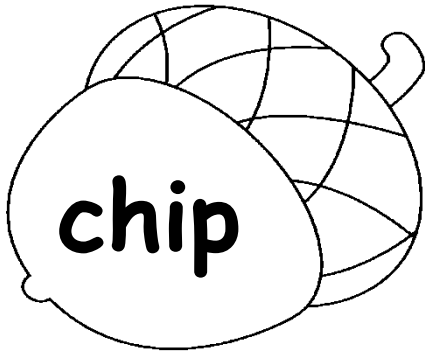

Squirrel Search (continued)

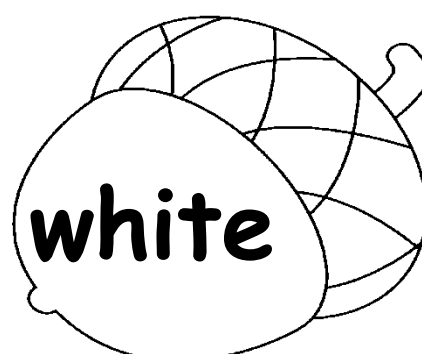
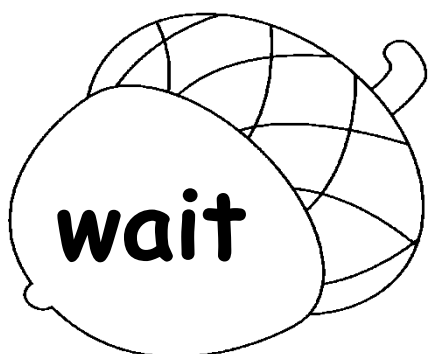
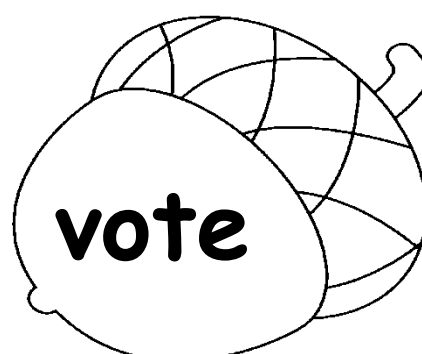
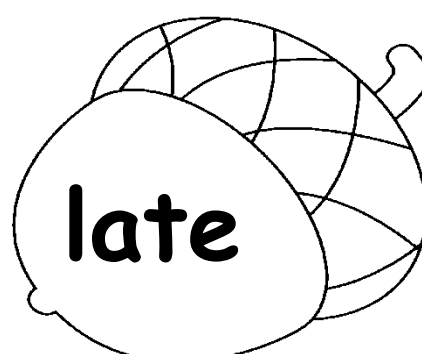
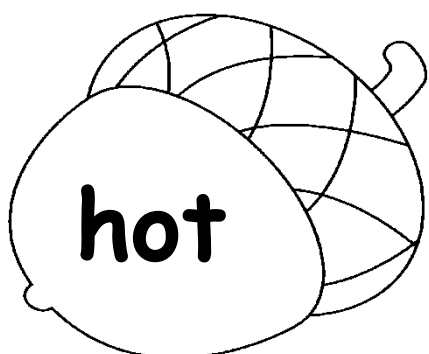
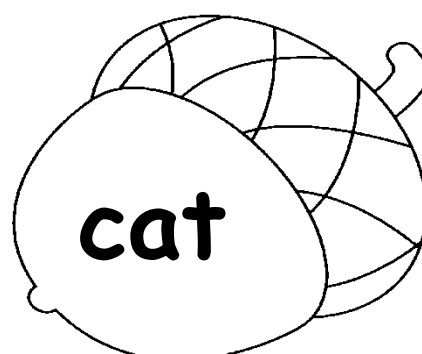
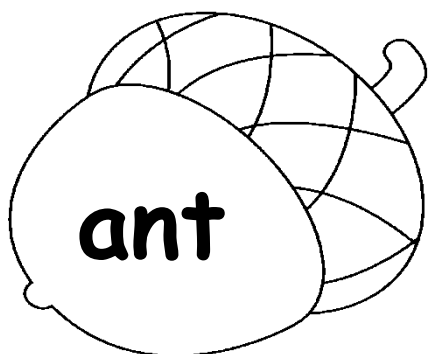

Squirrel Search (continued)

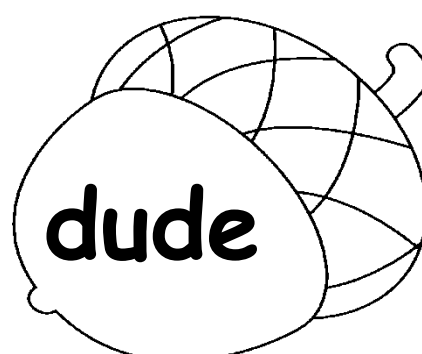
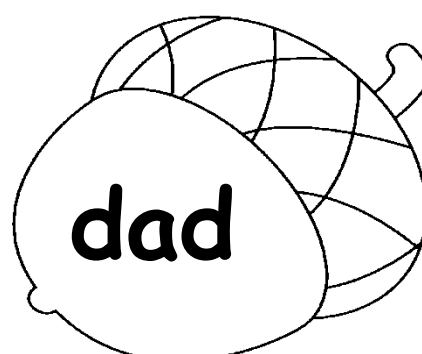
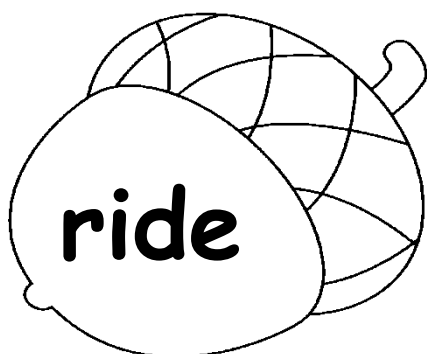
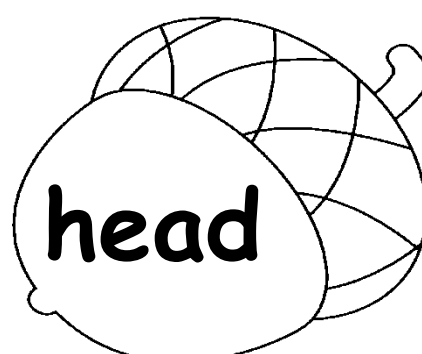
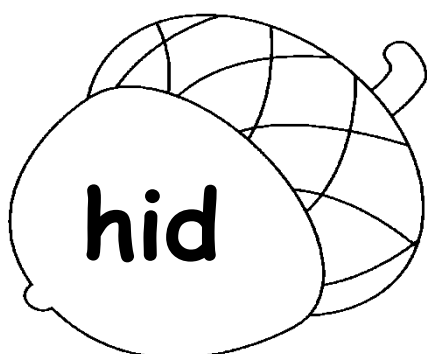
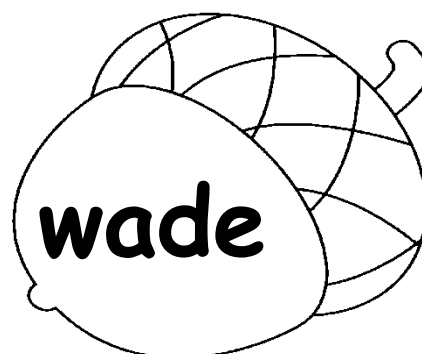
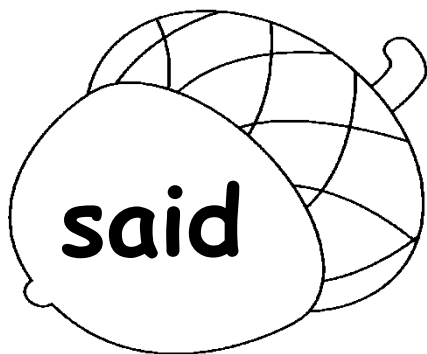

Squirrel Search (continued)

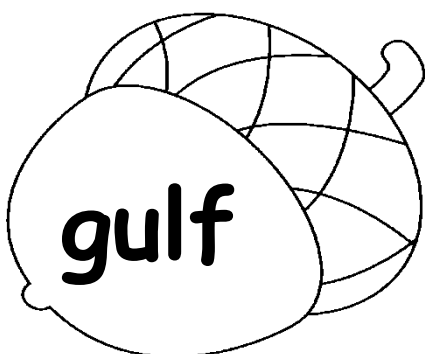
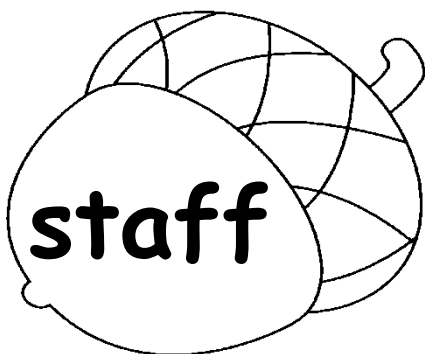
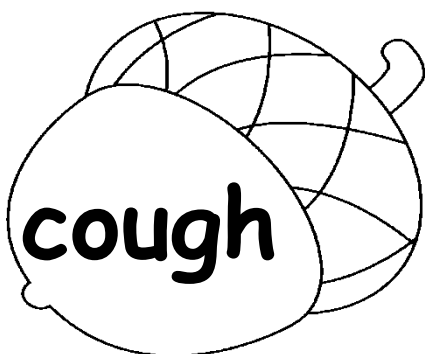
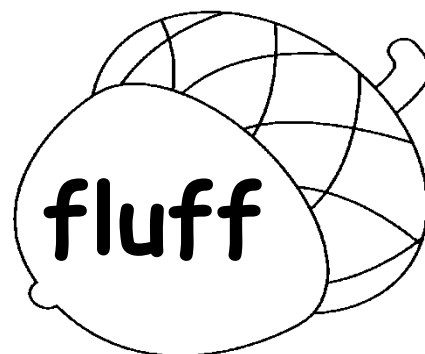
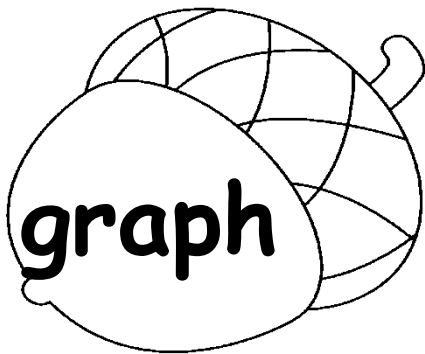

p

t

d

f

Beginning Blends Bingo - Game Card #1

sh	bl	fl
ch	st	sn
wh	gl	ch

Beginning Blends Bingo - Game #1

(Have your child cut these pieces out)

sheep	blouse	flag
chair	stamp	snail
whale	glue	chip

Beginning Blends Bingo - Game Card #2

sk	gr	cr
dr	pr	fr
tr	br	sm

Beginning Blends Bingo - Game #2

(Have your child cut these pieces out)

skeleton	grass	cracker
dress	prize	frog
trunk	bread	smile

Beginning Blends Bingo - Game Card #3

sl	tw	sc
th	sw	cl
pl	qu	sp

Beginning Blends Bingo - Game #3

(Have your child cut these pieces out)

sleep	twins	school
thumb	sweep	clown
plane	queen	spider

Ending Sounds Match

